



Sprinter

Fuse Assignment Supplement



9075846909

Order no. T907 0369 13 Part no. 907 584 69 09 Edition 2021-06



Publication details

Internet

Further information on Freightliner vans can be found at:

<https://www.freightlinersprinterusa.com>

Documentation team

©Mercedes-Benz AG: not to be reprinted, translated or otherwise reproduced, in whole or in part, without written permission from Mercedes-Benz AG.

Vehicle manufacturer

Mercedes-Benz AG

Mercedesstraße 120

70372 Stuttgart

Germany

Vehicle dealers

Daimler VANS USA, LLC

One Mercedes-Benz Drive

Sandy Springs, GA 30328

<https://www.mbusa.com> (USA only)

<https://www.freightlinersprinterusa.com>

Customer Assistance Center:

1-877-762-8267

Daimler VANS USA, LLC is a Daimler AG enterprise.

Symbols	2
----------------------	----------

Fuses and relays	3
-------------------------------	----------

Notes on fuses	3
----------------------	---

Fuses and relays in the co-driver foot-well	3
---	---

Fuses on the outside of the driver's seat base	8
--	---

Fuses/relays in the base of the driver's seat and in the battery box	11
--	----

Index	15
--------------------	-----------

2 Symbols

In this Supplement, you will find the following symbols:

 **DANGER** Danger due to not observing the warning notices

Warning notices draw your attention to hazards that may endanger your health or life, or the health or life of others.

► Observe the warning notices.

 **ENVIRONMENTAL NOTE** Environmental damage due to failure to observe environmental notes

Environmental notes include information on environmentally responsible behavior or environmentally responsible disposal.

► Observe environmental notes.

 **NOTE** Damage to property due to failure to observe notes on material damage

Notes on material damage inform you of risks which may lead to your vehicle being damaged.

► Observe notes on material damage.

 These symbols indicate useful instructions or further information that could be helpful to you.

► Instructions

(→ Further information on a topic page)

Display Display in the multifunction display/media display

* Indicates a cause

Notes on fuses

⚠ WARNING Risk of accident and injury due to overloaded lines

If you manipulate or bridge a faulty fuse or if you replace it with a fuse with a higher amperage, the electric line could be overloaded.

This could result in a fire.

- ▶ Always replace faulty fuses with specified new fuses containing the correct amperage.

! NOTE Damage or malfunctions caused by moisture

Moisture may cause damage to the electrical system or cause it to malfunction.

- ▶ When the fuse box is open, make sure that no moisture can enter the fuse box.
- ▶ When closing the fuse box, make sure that the seal of the lid is positioned correctly on the fuse box.

You can find further information on fuses in the vehicle Operator's Manual.

Fuses and relays in the co-driver footwell

Fuse assignment

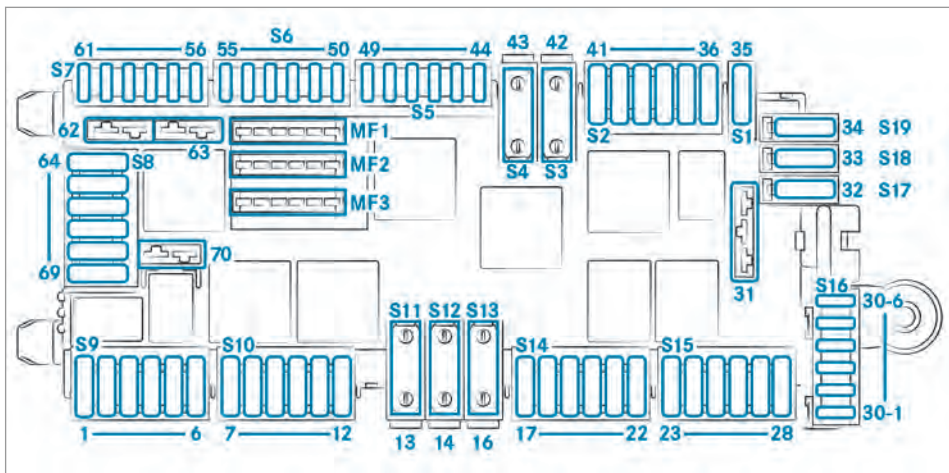

No.	Consumer	Fuse rating
MF1		
15-2	Engine control unit	5 A
15-2	Common Powertrain Module (CPC)	5 A
15-2	ESP® control unit	5 A
15-2	All-wheel drive control unit	5 A
15-2	Pre-installation for Onboard Logic Unit (OLU) control unit	5 A
15-2	Terminal 15, special signal, cockpit body manufacturer	5 A
MF2		
15-1	Feedback cable, terminal 15 relay	5 A
15-1	Headlamp range control, halogen headlamp	5 A
15-1	Tachograph TCO	5 A
15-1	Active Brake Assist radar sensor	5 A
15-1	Deactivation of reverse warning device, power take-off, working speed control	5 A
15-1	Device installation frame, connector coupling	5 A
MF3		
30-T	Multifunction camera	7.5 A
30-T	Unassigned	
30-T	Connector coupling, device installation frame, roof	7.5 A
30-T	Terminal 30T, special signal, cockpit body manufacturer	7.5 A
30-T	Instrument cluster	7.5 A
30-T	Device installation frame, cockpit	7.5 A
S9		
1	Unassigned	

No.	Consumer	Fuse rating
2	Common Powertrain Module (CPC)	10 A
3	Engine control unit OM642/OM651/M274	10 A
	Engine control unit OM654	5 A
4	Automatic transmission central oil pump	7.5 A
5	Common Powertrain Module (CPC)	10 A
6	Radiator fan control, terminal 87c	5 A
S10		
7	Automatic transmission intelligent servo module	30 A
8	Body controller	30 A
9	Body controller	30 A
10	Heating, SCR catalytic converter	30 A
11	Overhead control panel (standard)	10 A
	Overhead control panel, Cab Chassis	10 A
	Overhead control panel, delivery vehicle	10 A
	Overhead control panel (high)	15 A
12	Pump, SCR catalytic converter	15 A
S11		
13	Automatic transmission	60 A
S12		
14	ESP® valves (Premium), vehicles with electric parking brake	40 A
	ESP® valves (Standard)	25 A

No.	Consumer	Fuse rating
S13		
16	ESP® pump	60 A
S14		
17	Body controller	30 A
18	Body controller	30 A
19	Terminal strip for body manufacturer electrical connection	10 A
20	Co-driver door control unit	25 A
21	Driver's door control unit	25 A
22	Air suspension (LFA) control unit	10 A
S15		
23	Unassigned	
24	USB port (cockpit), USB port (stowage compartment), converter socket 115 V/230 V	7.5 A
25	Cigarette lighter	15 A
	Socket, center console	15 A
26	Socket, instrument panel	15 A
27	Converter socket, 115 V/230 V	25 A
28	Radio pre-installation, cargo liftgate, DSP connecting point, antenna voltage converter, 115 V/230 V converter socket for vehicles with auxiliary battery	7.5 A
S16		
30-1	Unassigned	
30-2	Tachograph TCO	7.5 A
30-3	Central locking system	5 A
30-4	Anti-theft alarm system (ATA)	5 A
30-5	Unassigned	

No.	Consumer	Fuse rating
30-6	Electronic ignition lock control unit	10 A
31-A	Unassigned	
31-B	Starter power supply, relay	25 A
S17		
32	Unassigned	
S18		
33	Voltage dip limiter (SEB)	5 A
S19		
34	Electrics for body interior lighting	10 A
S1		
35	Ventilation blower regulator	30 A
S2		
36	Air conditioning control panel	5 A
37	Electric Steering Wheel Locking (ESTL)	5 A
38	Steering Column Switch Module (SCSM)	10 A
39	Digital signal processor pre-installation	10 A
40	Rotating beacon	5 A
41	Radio multimedia system/radio pre-installation	25 A
S3		
42	Unassigned	
S4		
43	Unassigned	
S5		
44	Switch panel, multimedia system	5 A
45	Mobile phone cradle (WMI)	5 A

No.	Consumer	Fuse rating
46	Multimedia connection unit (MMI)	7.5 A
47	Hermes (LTE communication module)	5 A
48	Telestart stationary heating	5 A
49	Central display	5 A
S6		
50	Additional headlamp, left (platform body manufacturer)	5 A
51	Additional headlamp, right (platform body manufacturer)	5 A
	Switch clock for the auxiliary heating air, terminal 15 relay	5 A
52	Control unit, airbag	7.5 A
53	Diagnostics	5 A
54	Relay supply	5 A
55	Engine connecting point (diesel), engine control unit (OM651/OM642/M274)	7.5 A
S7		
56	Control unit (OM654)	15 A
57	Soot particulate sensor, NO _x sensor, main catalytic converter (OM654)	15 A
	Soot particulate sensor	10 A
58	Engine, exhaust gas recirculation (EGR) (OM642/OM651)	10 A
	Engine (M274/OM654)	15 A
59	NO _x sensor before/after catalytic converter	10 A
60	Lambda sensor	7.5 A
	Coolant pump (OM654)	15 A
61	Engine (M274/OM651)	10 A
	Engine (OM642)	7.5 A

No.	Consumer	Fuse rating
	Engine (OM654)	5 A
H2		
62	Engine (M274/OM654)	15 A
	Engine (OM651/OM642)	20 A
63	Engine (M274)	20 A
	Engine (OM651/OM642/OM654)	25 A
S8		
64	Body controller	30 A
65	Body controller	30 A
66	Automatic transmission auxiliary oil pump	15 A
67	Control unit for fuel measurement (FSCM)	25 A
68	LED headlamp, right	15 A
69	LED headlamp, left	15 A
H2		
70	Windshield wipers	30 A

Relays in the co-driver footwell

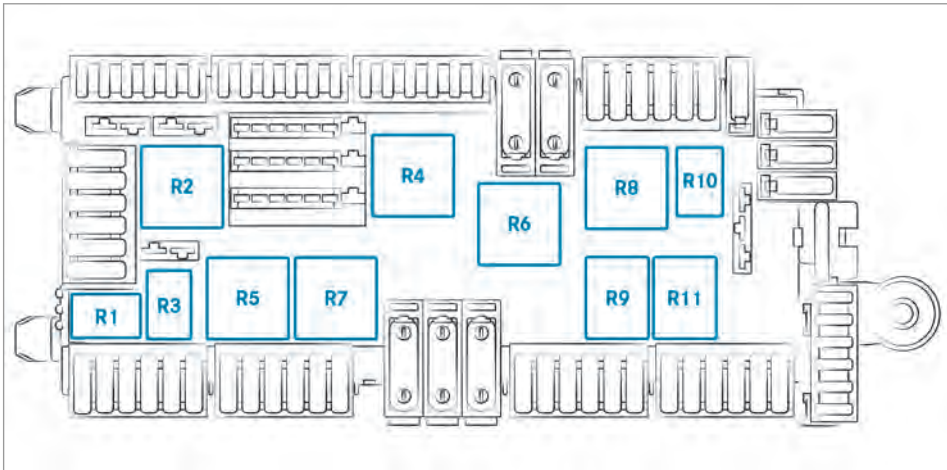

No.	Designation	Permissible current intensity
R1	Reserve	30 A
R2	Terminal 87, engine	50 A
R3	Terminal 87, Common Powertrain Module CPC	30 A
R4	Terminal 15	40 A
R5	Windshield wipers on/off	40 A
R6	Reserve	40 A
R7	Windshield wipers fast/slow	40 A
R8	Terminal 50, starter	40 A
R9	Terminal 15R (vehicles without auxiliary battery)	50 A
R10	Starter power supply, relay	30 A
R11	Terminal 15R (vehicles with auxiliary battery)	50 A

Fuses on the outside of the driver's seat base

Fuse assignment

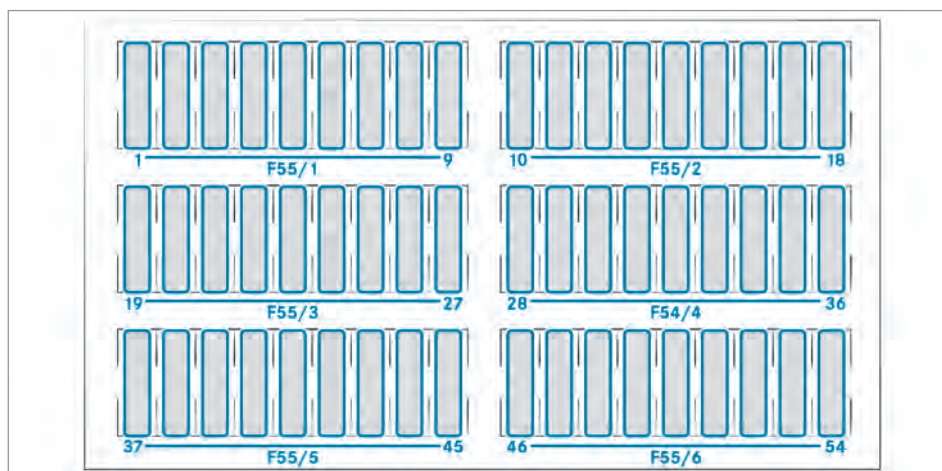

Fuse block F55/1

No.	Consumer	Fuse rating
1	Additional turn signal lamp	10 A
	Roof ventilator	15 A
2	Rear window wiper, right	15 A
3	All-wheel drive control unit	30 A
	4MATIC all-wheel drive control unit	30 A
4	Parking Package	5 A
	Rear view camera	
5	Driver seat adjustment control unit	25 A
	Seat heating control unit, driver/co-driver with individual seat	
6	Driver lumbar support	10 A
	Co-driver lumbar support	
7	Co-driver seat adjustment control unit	25 A

No.	Consumer	Fuse rating
	Seat heating control unit, co-driver bench seat	
8	Tire pressure monitoring system	5 A
	Motion detector	
9	Rear blower	25 A

Fuse block F55/2

No.	Consumer	Fuse rating
10	Trailer coupling control unit, right	25 A
11	Trailer coupling control unit (socket)	15 A
12	Trailer coupling control unit, left	25 A
13	Trailer coupling control unit (charging cable)	15 A

No.	Consumer	Fuse rating
14	Parameterizable special module control unit	25 A
15	Parameterizable special module control unit	25 A
16	Terminal 30, terminal strip for body manufacturer's electrical connection	25 A
17	Hot-water auxiliary heater	20 A
18	Terminal 30T for terminal 15 relay	5 A

Fuse block F55/3

No.	Consumer	Fuse rating
19	Rear window heater, left	15 A
	Additional caravanning unit (PWM 1)	25 A
20	Rear window heater, right	15 A
	Additional caravanning unit (PWM 2)	25 A
21	Rear window heater relay	30 A
	Additional caravanning unit control unit	5 A
22	Trailer brake booster	30 A
23	Cargo liftgate/dumper vehicle (pre-installation)	7.5 A
	Roof ventilator	5 A
24	Terminal strip for electrical connection (body manufacturer)	15 A
25	Rear view camera/rear view camera pre-installation	5 A
	Rear view camera display, inside rearview mirror	
26	Hot-air auxiliary heater	15 A

No.	Consumer	Fuse rating
	Supply, terminal 15, auxiliary battery relay	20 A
	Central locking system, delivery vehicle	
27	Auxiliary battery voltage measurement	5 A

Fuse block F55/4

No.	Consumer	Fuse rating
28	Sliding door, left	15 A
	Electric sliding door, left	30 A
	Intermediate door, delivery vehicle	5 A
	Speed delivery door	30 A
29	Sliding door, right	15 A
	Electric sliding door, right	30 A
	Reading lamp, delivery vehicle	5 A
	Speed delivery door	30 A
30	Antenna switch box	5 A
	Interior lighting, body, delivery vehicle	
31	Automatic transmission, Ultracap	10 A
32	Automatic transmission, 7G-TRONIC PLUS	10 A
33	Pre-installation for Onboard Logic Unit (OLU)	30 A
34	Pre-installation, siren	15 A
	Pre-installation for camper van	30 A
	OLU Connect Unit	5 A
35	Rotating beacon with siren	15 A
	Pre-installation for camper van	30 A
	OLU Compute Unit	10 A

No.	Consumer	Fuse rating
36	Pre-installation for camper van	30 A
	OLU Compute Unit	10 A

Fuse block F55/5

No.	Consumer	Fuse rating
37	Electrical step, left	10 A
38	Electrical step, right	10 A
39	Warning buzzer, electrical steps	5 A
40	Unassigned	ATO
41	Air spring	5 A
42	Retarder	5 A
43	Socket, cab	15 A
44	Socket, D-pillar, left	15 A
45	Socket, D-pillar, right	15 A

Fuse block F55/6

No.	Consumer	Fuse rating
51	USB port, side wall, front left	7.5 A
	USB port, side wall, front left (with sliding door, left)	5 A
52	USB port, side wall, front right	7.5 A
	USB port, side wall, front right (with sliding door, right)	5 A
53	USB port, side wall, rear left (bus)	7.5 A
	USB port, side wall, rear left (Passenger Van)	5 A
54	USB port, side wall, rear right (bus)	7.5 A
	USB port, side wall, rear right (Passenger Van)	5 A

Fuses/relays in the base of the driver's seat and in the battery box

Fuse assignment

Additional fuses and relays etc. are located in the seat base of the driver's seat:

- For the windshield heater
- For other major assemblies, such as power-steering pumps, auxiliary battery, battery cutoff relays and PTC heater boosters
- From the body manufacturers for retarders, cargo liftgate, hydraulic pump and dumper vehicle

i Always have the fuses and relays in the seat base replaced at a qualified specialist workshop.

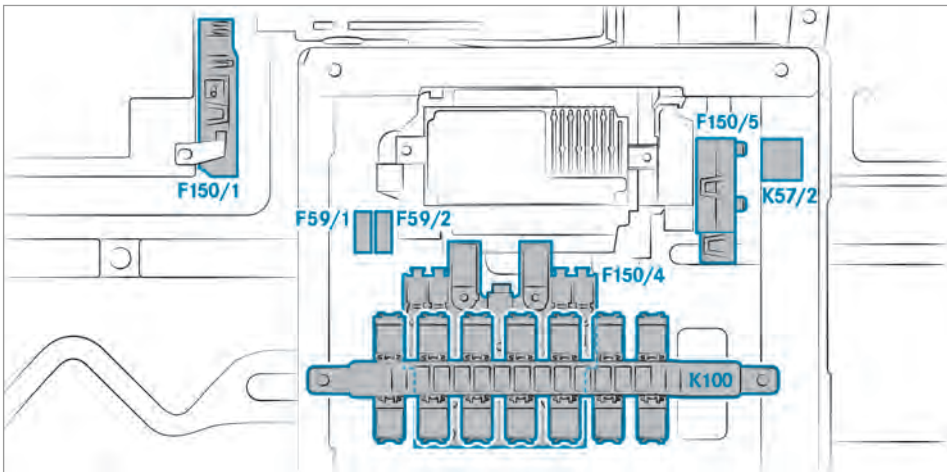

Fuse block F150/1 (MFB-1) in the battery box

No.	Consumer	Fuse rating
1	Battery sensor	
2	Unassigned	MIDI
3	Main fuse box (MFB-2)	Busbar
4	Power Distribution Center, terminal 30 (F30-1 - F30-6)	50 A
5	PTC heater booster	125 A

Fuse block F150/4 (MFB-2)

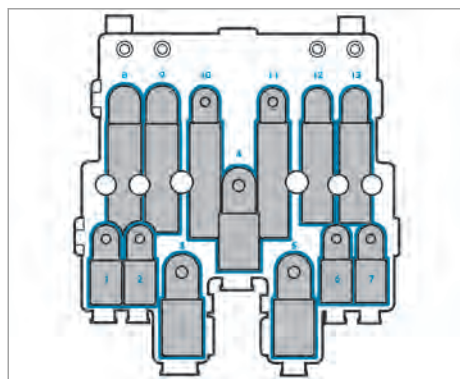

No.	Consumer	Fuse rating
1	Terminal 30T, fuse box, seat base of driver's seat (fuse block F55/1 - F55/6)	125 A
2	Electric steering	125 A
3	Alternator	300 A
	Alternator (code M60 or M61)	400 A
4	Unassigned	
5	Power Distribution Center (PDC)	175 A
6	Glow output stage (GZE)	80 A
7	Mono fan, air conditioning system	40 A
	Duo fan, air conditioning system	80 A
	Fan, radiator OM654/M274	100 A
8	Camper van (fuse block F55/4)	100 A
9	Camper van (code E1R)	150 A
	Camper van (code E1Y)	80 A
10	High performance roof-mounted air conditioning system (code HK4)	100 A
	Enhanced roof-mounted air conditioning system (code H08)	50 A
	Basic roof-mounted air conditioning system (code HH7)	25 A
	Camper van (without roof-mounted air conditioning system)	80 A
11	Auxiliary battery/battery cutoff relay	150 A
	Retarder without auxiliary battery	100 A

No.	Consumer	Fuse rating
12	Air suspension/camper van (without air suspension)	40 A
13	Windshield heater	80 A

Fuse block F150/5 (MFB-ZB)

No.	Consumer	Fuse rating
1	Retarder	100 A
2	Cargo liftgate/dumper vehicle (pre-installation)	250 A
3	Auxiliary battery	
4	Battery cutoff relay	150 A
5	DC/AC converter sockets with auxiliary battery	60 A
6	Hot-air auxiliary heater with auxiliary battery	25 A
	Hot air auxiliary heater, supply for additional caravanning unit with auxiliary battery	80 A
	Parcel service delivery vehicle	40 A

Individual fuses F59/1 and F59/2

No.	Consumer	Fuse rating
1	Windshield heater, left	40 A
2	Windshield heater, right	40 A

Relay holder K100

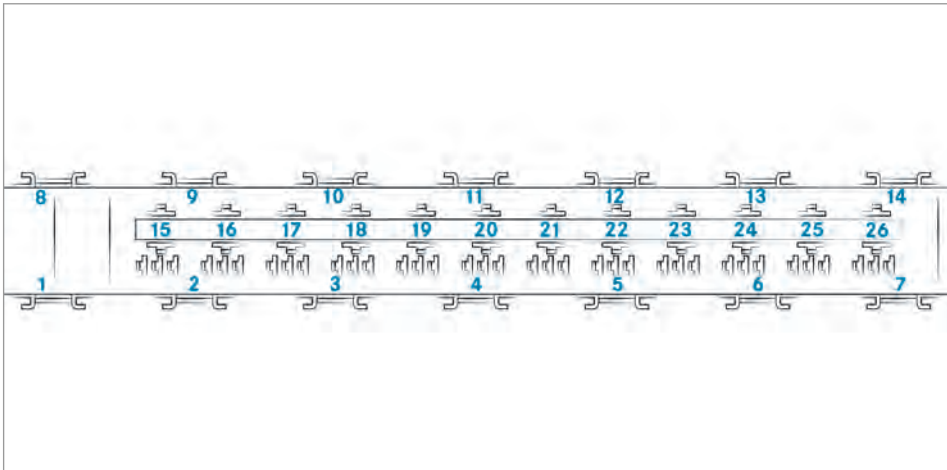

Right-hand-drive vehicles

No.	Designation
Supplementary relay, bottom	
1	Windshield heater
2	Terminal 15
3	Rear window heater
4	Sockets, rear compartment
5	Unassigned
6	Unassigned
7	Unassigned
Supplementary relay, top	
8	Unassigned
9	Unassigned
10	Unassigned
11	Unassigned
12	Unassigned
13	Unassigned
14	Unassigned
Mini-relay	

No.	Designation
15	Rear window wiper, right
16	Terminal strip body manufacturer
17	Switch, reverse warning device
18	Roof ventilator Interior lighting
19	Auxiliary oil pump
20	Electrical step, right 1
21	Electrical step, right 2
22	Electrical step, left 1
23	Electrical step, left 2
24	Siren Reading lamp, parcel service delivery vehicle
25	Rotating beacon with siren
26	Cargo liftgate Terminal 15 on auxiliary battery
Relay holder K57/2	
	Auxiliary battery relay

Left-hand-drive vehicles

No.	Designation
Supplementary relay, bottom	
1	Unassigned
2	Unassigned
3	Unassigned
4	Unassigned
5	Unassigned
6	Unassigned
7	Unassigned
Supplementary relay, top	
8	Windshield heater
9	Terminal 15
10	Rear window heater
11	Sockets, rear compartment
12	Unassigned
13	Unassigned
14	Unassigned
Mini-relay	
15	Rear window wiper, right
16	Terminal strip body manufacturer
17	Switch, reverse warning device
18	Roof ventilator
	Interior lighting
19	Auxiliary oil pump
20	Electrical step, right 1
21	Electrical step, right 2
22	Electrical step, left 1
23	Electrical step, left 2
24	Siren
	Reading lamp, parcel service delivery vehicle
25	Rotating beacon with siren

No.	Designation
26	Cargo liftgate
	Terminal 15 on auxiliary battery
Relay holder K57/2	
	Auxiliary battery relay

F**Fuses**

Notes on fuses..... 3

Fuses on the outside of the driver's seat base

Fuse assignment..... 8

Fuses/relays in the base of the driver's seat and in the battery box

Fuse assignment..... 11

Relay holder K100..... 13

Fuses/relays in the front-passenger footwell

Fuse allocation..... 3

Relay assignment..... 7

